



Discreet Sound Solutions



8 Ohm

CELO8S

High-end 8" ceiling subwoofer

- ▶ Integrated stereo crossover
- ▶ Low frequencies in the most natural way possible
- ▶ Terminal block connection
- ▶ QuickFit™ mounting system
- ▶ SlimLine™ grill fixation

*“Energetic depths,
from above.”*

The CELO8S is the next step in our journey to provide an impeccable musical atmosphere. This 8" ceiling subwoofer is fitted with a stiff and light aluminum membrane, minimizing ceiling vibrations and resulting in energetic depths from above, while the open back design enables the CELO8S to reproduce low frequencies in the most natural way possible. Its integrated stereo crossover enables you to effortlessly connect your satellite speakers, resulting in the absolute finest full-range sound experience in the most efficient way possible.

To overcome the architectural challenges of the most luxurious interior designs, the CELO8S is fitted with our SlimLine™ grill design with an exceptionally thin border of only 1 mm and a minimized grill depth, extruding merely 3.2 mm from the ceiling surface. In addition, the grill is completely paintable, making the speaker disappear without sacrificing any sound quality. This elegant and unobtrusive grill is held in place by means of powerful neodymium magnets, making assembly and disassembly simple and reliable.

Without the speaker grill installed, it's clear for anyone to see that the CELO8S is made by using only the highest quality materials, guaranteeing an unsurpassed sound experience. This results in true to nature sound reproduction for a warm and detailed sound with an RMS power of 50 Watt per channel and 100 Watt when connected in parallel.



*“The next step in our journey to provide you
an impeccable musical atmosphere.”*

① Phase switch

Depending on the acoustical properties of your room and placement of the subwoofer, the sub can be better integrated into your room when switched to either 0° or 180° by adjusting the phase switch. We recommend 0° when all speakers are mounted in a flat wall or ceiling.



② Balance correction switch

When installed with accompanying satellite speakers, the volume of these satellites relative to the subwoofer can be increased and decreased by 3 dB, according to the installation setup and preferred sound.



SONA series

On-wall / On-ceiling solutions

The ultra-compact ATEO2 model smoothly integrates into any interior like no other surface mount loudspeaker. The sound originates from a 2" aluminum cone driver which provides a full-range, warm and detailed sound, with an improved response in the low frequencies due to the ported design.

Supported by the CELO8S 8" ceiling subwoofer that delivers detailed and punchy bass, while the open back design enables the CELO8S to reproduce low frequencies in the most natural way possible. It comes fitted with an integrated stereo crossover that enables you to effortlessly connect your satellite speakers, resulting in the absolute finest full-range musical atmosphere.

Powered by the EPA152 energy efficient Class-D stereo amplifier this system, using four ATEO2 loudspeakers, can cover areas of around 100 m² with clear and powerful background music.



More SONA solutions :

- [SONA82.8S](#)
8 x ATEO2D, 1 x CELO8S, 1 x EPA152



SONA82.4

4 x ATEO2, 1 x CELO8S, 1 x EPA152

Available colours:  





SENSO series

In-ceiling solutions

The tiny and nearly invisible design of the CELO2 speakers makes the SENSO82.4S set one of the most compact high-end in-ceiling audio solutions with subwoofer that will draw your attention only through its extraordinary sound.

Supported by the CELO8S 8" ceiling subwoofer that delivers detailed and punchy bass, while the open back design enables the CELO8S to reproduce low frequencies in the most natural way possible. It comes fitted with an integrated stereo crossover that enables you to effortlessly connect your satellite speakers, resulting in the absolute finest full-range musical atmosphere.

Powered by the EPA152 energy efficient Class-D stereo amplifier this system, using four CELO2 loudspeakers, can cover areas of around 100 m² with clear and powerful background music.

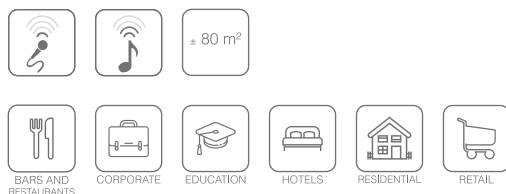

More SENSO solutions :

- [SENSO82.8](#)
8 x CELO2D, 1 x CELO8S, 1 x EPA152



SENSO82.4

4 x CELO2, 1 x CELO8S, 1 x EPA152

Available colours: B W



NOBA8

Compact 8" bass cabinet

- ▶ Innovative & unique design
- ▶ Countless mounting options
- ▶ Integrated class-D amplifier
- ▶ WaveDynamics™ technology



*“When design
meets sound.”*

NOBA is characterized by an innovative & unique design. With its curved shape, made of 4 mm thick aircraft graded aluminum and its extremely powerful 8” woofer of 300 Watts, the NOBA is able to deliver an unheard low frequency response for its small woofer size.

The perfect acoustic experience is guaranteed when the entire audio frequency spectrum is equally distributed. The slick look of the NOBA allows it to be placed against a wall, on the ceiling or even underneath furniture, yet due to the unique composition of its parts, NOBA ensures a much better spreading of sound waves than other similar cabinets. NOBA's integrated class-D amplifier provides an impressive clarity of 150 Watts for both of the top speaker outputs to ensure impeccable sound division.

The brand new bass cabinet uses AUDAC's WaveDynamics™ technology, which allows the user to easily set up the optimal acoustic configuration. The user can simply load its preferred audio settings through NOBA's integrated USB input.

WaveDynamics™

A complete library of set solution presets is available for your projects, making it as easy as picking the right file, loading it & play! Besides the optimal acoustic configurations, this library also includes the loudspeaker performance parameters providing a bulletproof protection for your audio system.

For specific projects, custom WaveDynamic™ configurations can be made using the AUDAC System manager.

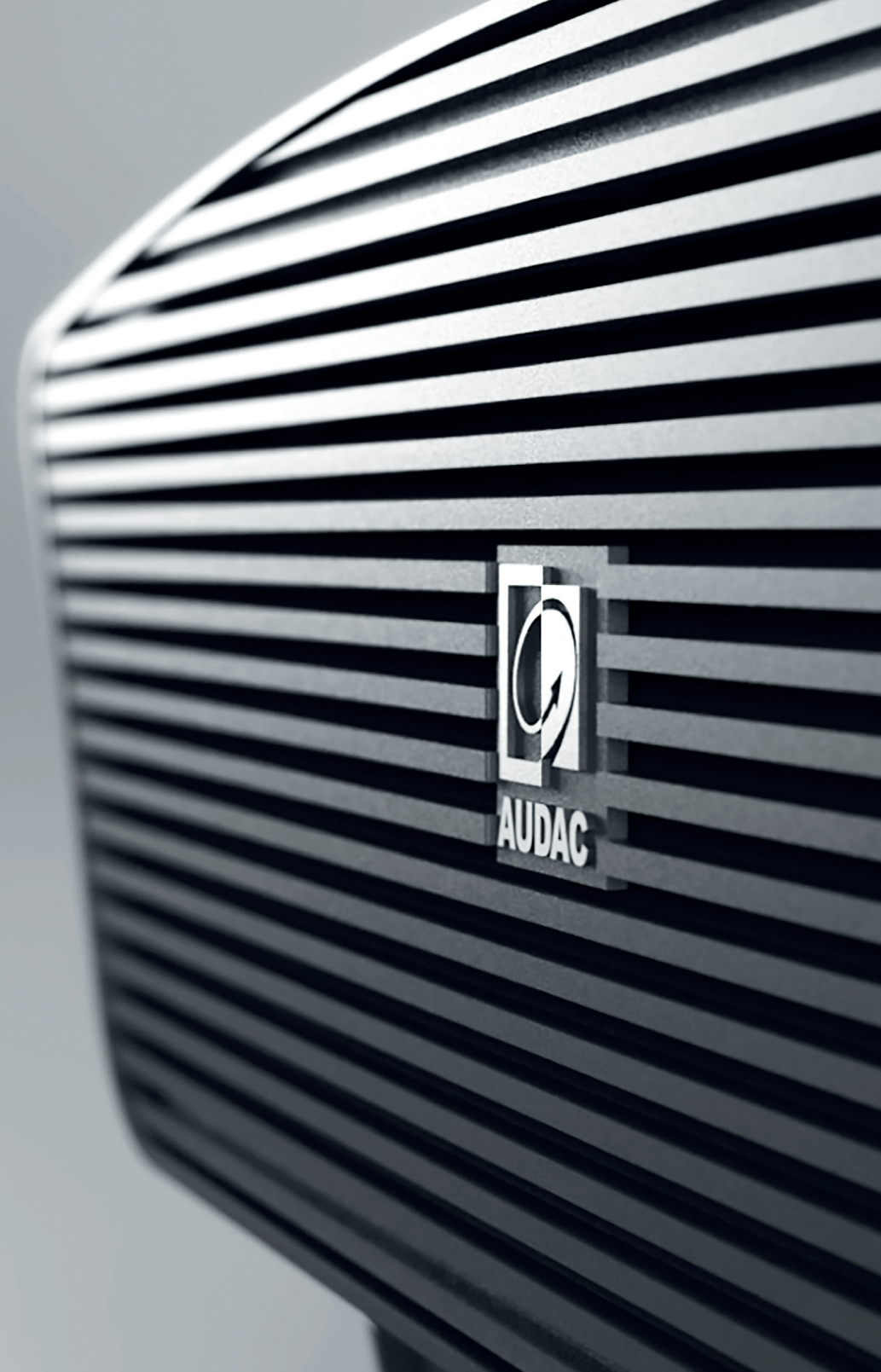

- ① WaveDynamics™ DSP and loudspeaker management
- ② 600 Watts Class-D Power amplifier
- ③ USB connection for preset loading & control
- ④ Satellite amplifier for set solutions (2.1)
- ⑤ Software configurable standby function (energy-star)
- ⑥ Wide operation range switch mode power supply with power factor correction



Limiter



Digital Audio Filters



Speaker Protection



Dynamic Bass



Speaker Presets



Energy Efficiency



System Manager



- ① Low loss & low temperature dependency suspension
- ② 2.4" voice coil for high power handling
- ③ Impressive motor strength and accurate displacements due to large magnet size
- ④ High excursion capability

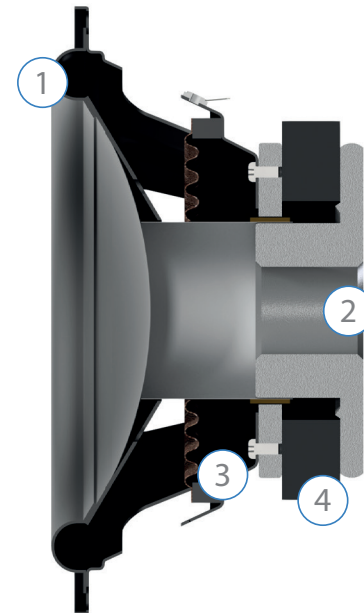

Countless mounting options

The unique design, with its curved shape and slick look of the NOBA allows it to be placed against a wall, on the ceiling or even underneath furniture.

The optional wall or ceiling mount bracket provides a great ease for installing the NOBA in one good-looking entity.



MBK410C

Optional ceiling mount bracket

Available colours:  

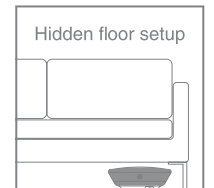
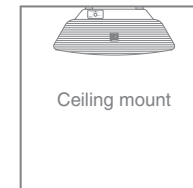
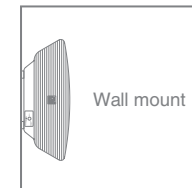

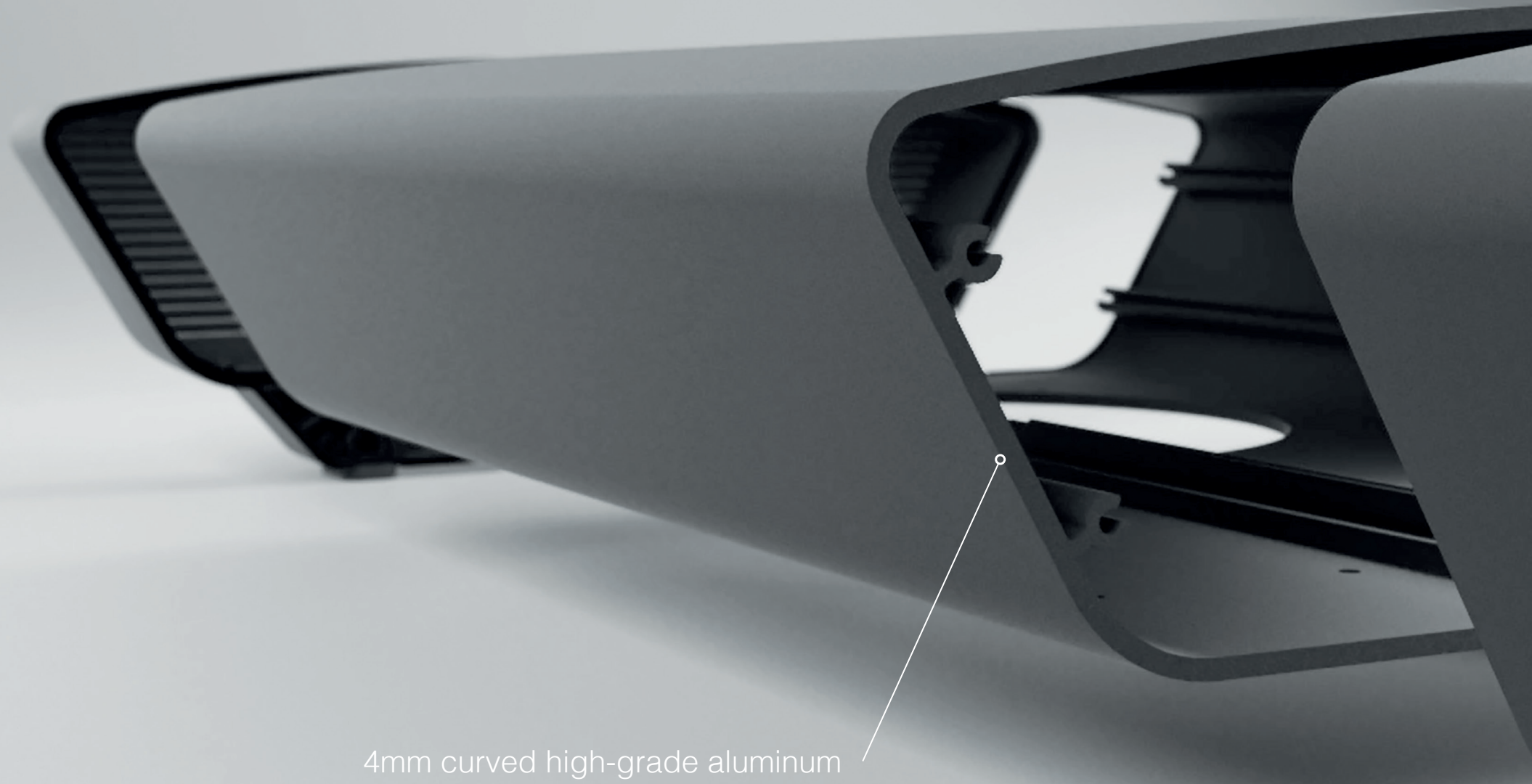

4mm curved high-grade aluminum

Full controllability
from the tip of your finger

- ① Mute switch
- ② Audio balance control
- ③ Volume control

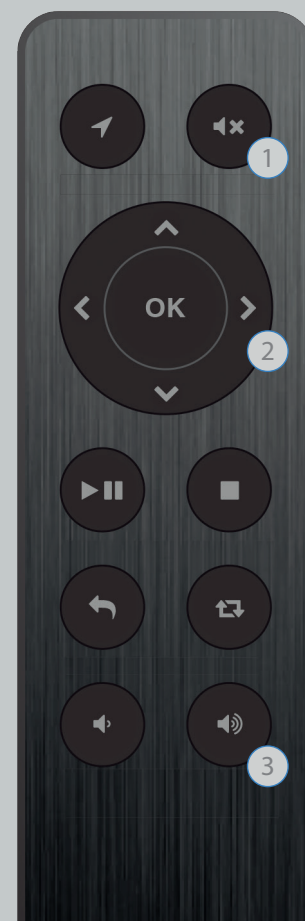

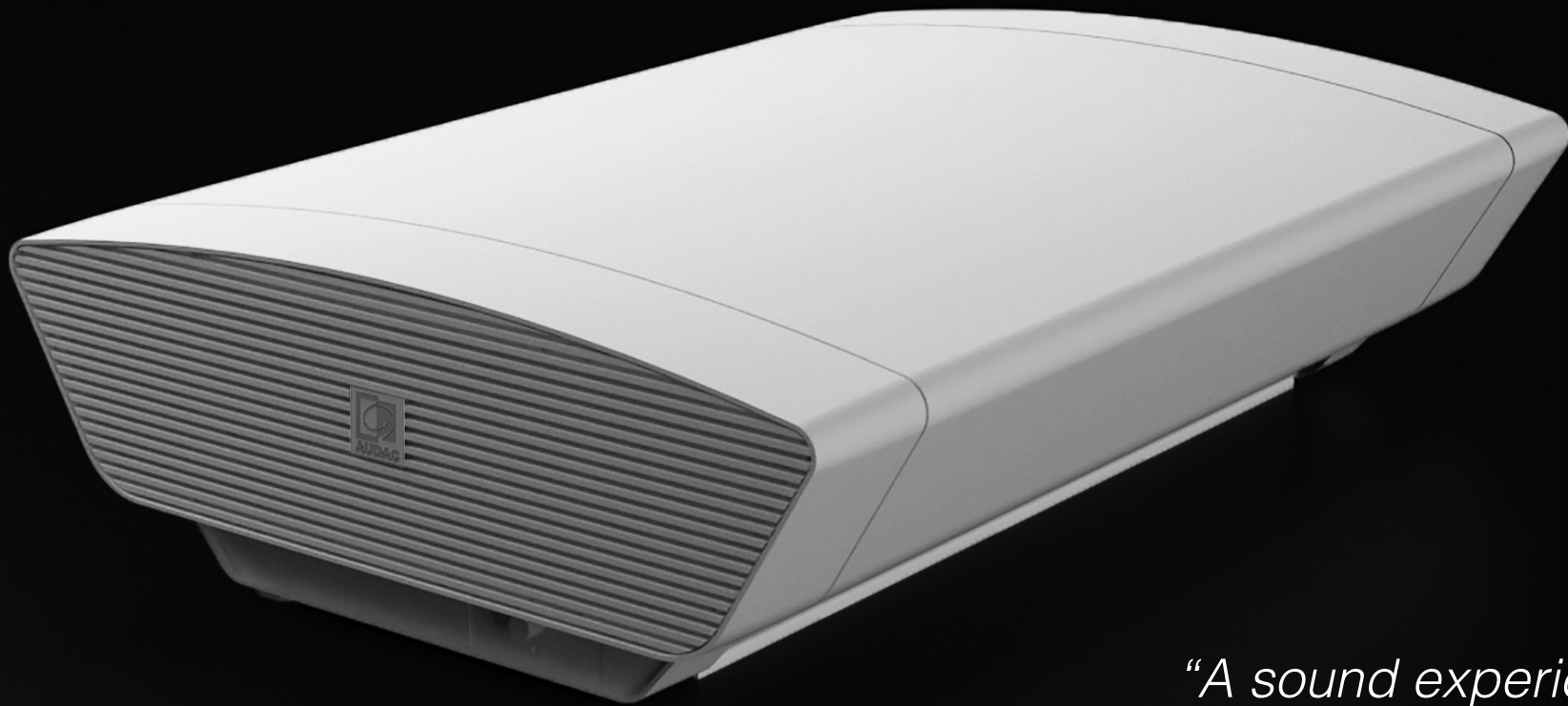

*“A sound experience
you won’t hide.”*

Get even more out of the NOBA solutions

All great NOBA solutions are available in a + version, these are accompanied with a AMP523MK2 module. This extra module will increase the amount of inputs for the audio system and open new control possibilities. Advanced remote control over the system is now possible while using any computer browser or applying the freely available AUDAC Touch™ 2 application for smart devices. While optional wall panels can increase the existing microphone and 4 line inputs to an extra line or microphone input or a control panel can select the desired audio source and volume.

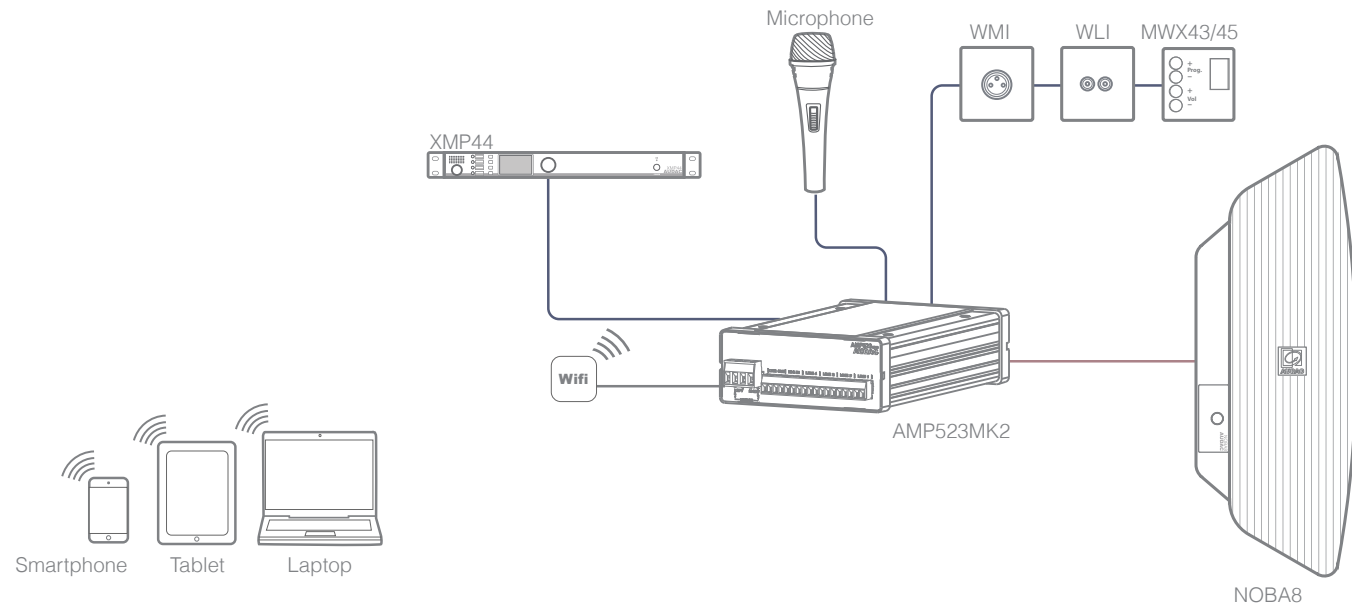

SONA series

On-wall / On-ceiling solutions

The SONA series provides a stunning and elegant design whilst delivering a sound experience that will leave its listeners stunned. Thanks to the combination of the extremely compact ATEO loudspeakers and the powerful NOBA bass cabinet of only 149mm thick, a perfect balance between sound clarity and power can be attained. A perfect acoustical match is accomplished by the WaveDynamics™ technology which also provides a bulletproof protection for your audio system.

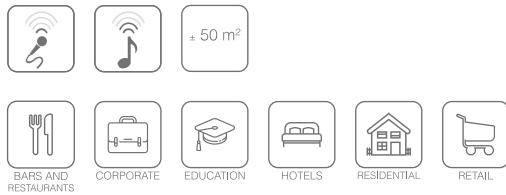

More SONA solutions :

- **SONA2.5**
4 x ATEO2 8Ω, 1 x NOBA8A
- **SONA2.9**
8 x ATEO2D 16Ω, 1 x NOBA8A
- **SONA4.3**
2 x ATEO4, 1 x NOBA8A
- **SONA4.5**
4 x ATEO4, 1 x NOBA8A



SONA2.3
2 x ATEO2, 1 x NOBA8A

Available colours: **B** **W**





Marshall

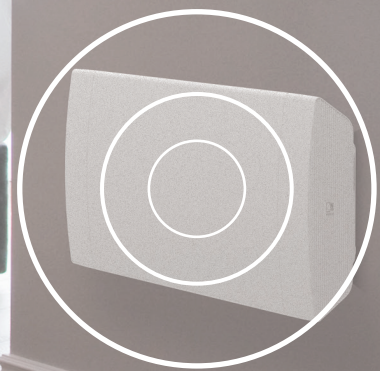

SENSO series

In-ceiling solutions

Sometimes a larger size speaker doesn't fit the interior design. Normally you would have to choose a smaller speaker solution that does not have the right capacity to fill an entire room.

By choosing the SENSO solution you receive the best of both worlds. The ultra-compact size of the CELO2 lets them smoothly integrate into any interior, combined with the stealth design and rich sound of the powerful 8" NOBA8 bass cabinet, this solution will assure you a sound distribution that is unheard of.



RESTAURANTS

CORPORATE

EDUCATION

HOTELS

RESIDENTIAL

RETAIL

More SENSO solutions :

- **SENSO2.5**
4 x CELO2 8Ω, 1 x NOBA8A
- **SENSO2.9**
8 x CELO2D 16Ω, 1 x NOBA8A



SENSO2.3

2 x CELO2 8Ω, 1 x NOBA8A

Available colours: **B** **W**

CONGRESS series

Solutions with column speakers

Having a high speech intelligibility is crucial in an educational environment. But nowadays playback of high quality media has also become a necessity in order to have your students experience the entire essence of your message. An excellent audibility of speech in acoustically difficult environments can easily be achieved with the KYRA column loudspeakers. When combined with the warm low frequencies the NOBA bass cabinet delivers, a true-to-nature reproduction of music and speech is acquired. A perfect acoustical match is accomplished by the WaveDynamics™ technology which also provides a bulletproof protection for your audio system.

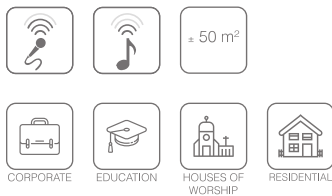

More CONGRESS solutions :

- **CONGRESS4.3A**
2 x KYRA12, 1 x NOBA8A



CONGRESS1.3A

2 x KYRA6, 1 x NOBA8A

Available colours: **B** **W**





CERRA series

In-wall solutions

Are you looking for a real breathtaking sound immersion? The NOBA has a height of only 149 mm and can be installed right underneath your lounge. Together with the MERO build-in wall speakers, this custom setup delivers an unsurpassed sound experience. A smooth integration into any interior thanks to the SlimLine™ grill that establishes the elegant look of the MERO in-wall speakers. A perfect acoustical match is accomplished by the WaveDynamics™ technology which also provides a bulletproof protection for your audio system.



BARS AND RESTAURANTS

CORPORATE

EDUCATION

RESIDENTIAL

RETAIL

More CERRA solutions :

- **CERRA2.5**
4 x MERO2 8Ω, 1 x NOBA8A
- **CERRA2.9**
8 x MERO2D 16Ω, 1 x NOBA8A

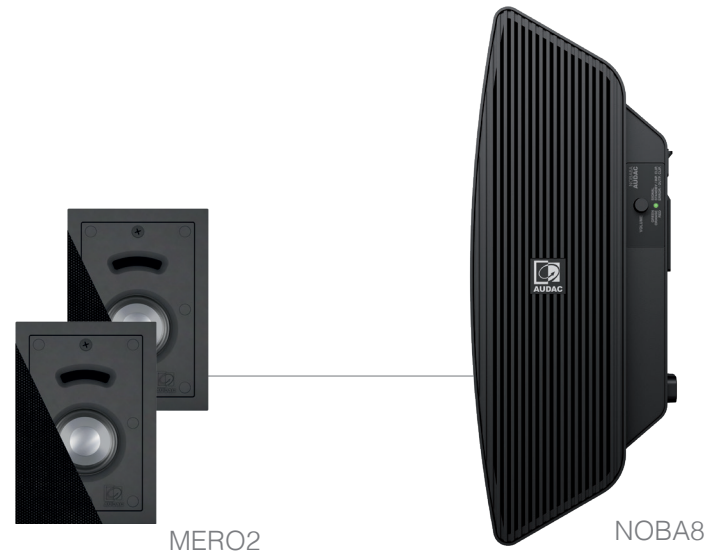

CERRA2.3

2x MERO2, 1 x NOBA8A

Available colours: **B** **W**



Matrix Systems

With innovation at the base of AUDAC's development, the brand offers comprehensive, expandable and powerful solutions for almost every situation.



Amplifiers

AUDAC offers a wide range of digital multi-channel amplifiers for single and multi-zone systems.



Modular audio systems

AUDAC pays great attention to its multimedia sources. The development of cutting edge digital audio technology has led to a complete range of sources that will inspire you!



Microphones

From the most robust hand-held or headset microphones to advanced paging systems, AUDAC provides you with the right extension for your voice.



Surface mount loudspeakers

The perfect match for fixed audio installations in modern environments, AUDAC offers different sizes of elegantly designed loudspeaker solutions.



Flush mount loudspeakers

Exceptional sound quality and value for a wide variation of applications. The extensive range of flush mount loudspeakers exists out of 5 different series that are complementary to one another.



Complete audio solutions

AUDAC offers a wide range of custom audio solutions. Pre-assembled loudspeakers packages specially and acoustically designed for each project.

Looking for advice or a custom solution?



✉ info@audac.eu

📘 facebook.com/audacaudio

🐦 twitter.com/audacaudio

📺 youtube.com/user/audacaudio